



BS 1250P, 1275P, & 1290P

1 1/4" PVC by 1/2" FPT

1 1/4" PVC by 3/4" FPT

1 1/4" PVC by
Swing Pipe Barb

Dimensions (installed):

BS 1290P:

- 4.54 inches - bottom of saddle to top of swing pipe barb
- 2.75 inches - top of pipe to top of swing pipe barb
- 2.60 inches at widest point

BS 1275P & 1250P:

- 3.63 inches - bottom of saddle to top of spike
- 1.7 inches - top of pipe to top of spike
- 2.60 inches at widest point

- For use on 1 1/4" Class 160 & 200 PVC pipe*
- 7 Gallons per minute at 40 PSI
- 12 Gallons per minute at 60 PSI
- Rubber grommet seals spike to pipe
- Friction loss equivalent of 3 ft of pipe
- Withstands repeated freeze/thaw cycles and ground shift & sheering
- Made of high grade ABS material
- Tested to over 1 million on/off cycle without a leak

*Withstands over 900 PSI without a leak. Pipe will burst first.

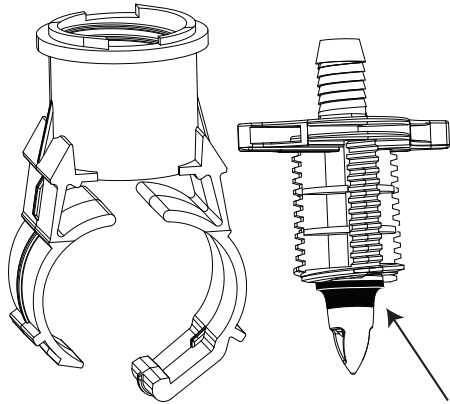

Rubber Grommet seals spike to pipe

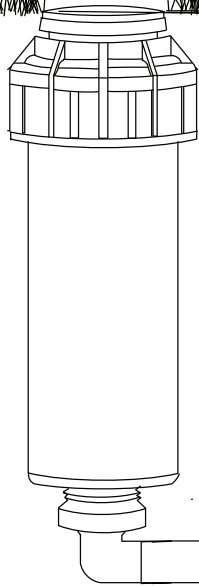
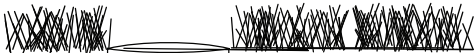

BS 12900P should be mounted horizontal

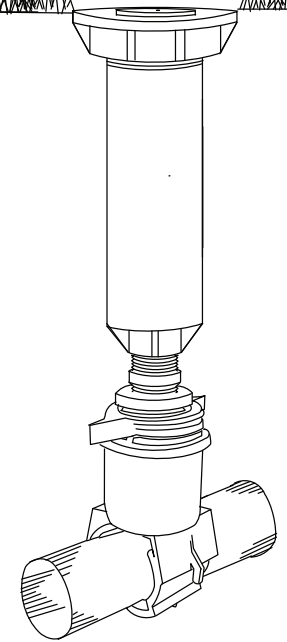
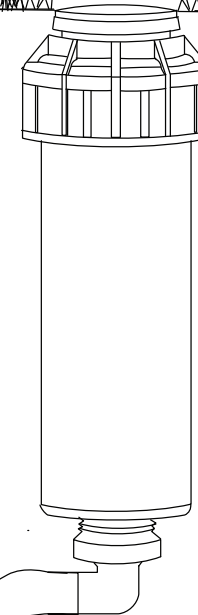
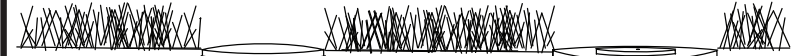

BS 12750P with 3/4" to 1/2" Riser Application

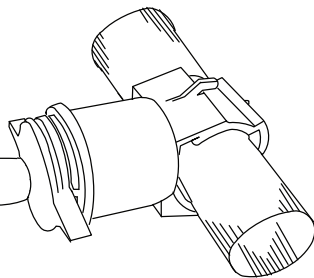

BS 12500P with Swing Pipe Fitting Application

PACKAGING QTYS.

PART	OUTLET	PACKAGE	CARTON (MIN ORDER)
BS 12500P	1/2" FPT	25	200
BS 12750P	3/4" FPT	25	200
BS 12900P	Swing Pipe Barb	25	200