



# BS 2590, 2550, & 2575

25mm poly by Swing Pipe Barb

25mm poly  
by 1/2" FPT

25mm poly  
by 3/4" FPT

**Dimensions (installed):** for pipe with 32mm OD

**BS 2590:**

- 101mm - bottom of saddle to top of swing pipe barb
- 69mm - top of pipe to top of swing pipe barb
- 66mm at widest point

**BS 2550 & 2575:**

- 79mm - bottom of saddle to top of spike
- 43mm - top of pipe to top of spike
- 66mm at widest point

- For use on 25mm polyethylene pipe\*
- 7 Gallons per minute at 40 PSI
- 12 Gallons per minute at 60 PSI
- 40% less friction loss than insert fittings
- Friction loss equivalent of 3.8 ft of pipe
- Withstands repeated freeze/thaw cycles and ground shift & sheering
- Made of high grade ABS material
- Tested to over 1 million on/off cycles without a leak

\*Withstands over 400 PSI without a leak. Pipe will burst first.

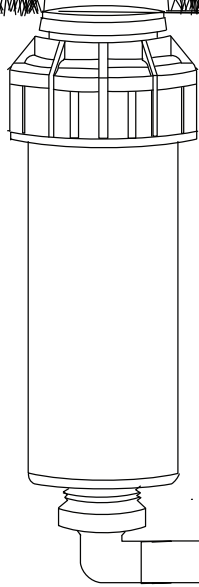
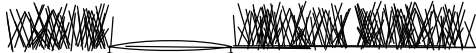
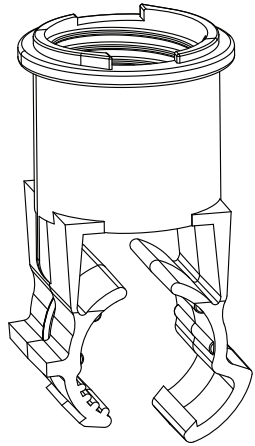

BS 2590 should be mounted horizontal

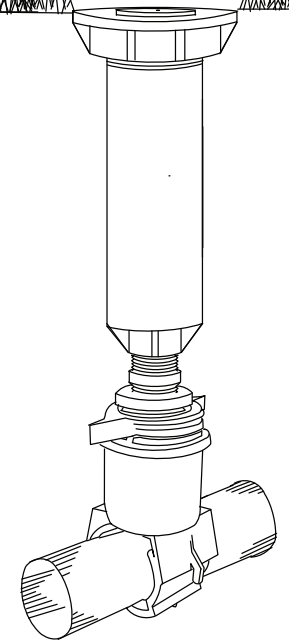
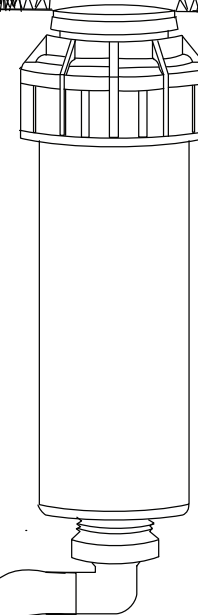
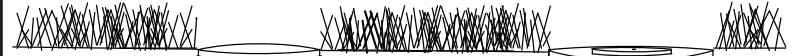

BS 2575 with 3/4" to 1/2" Riser Application

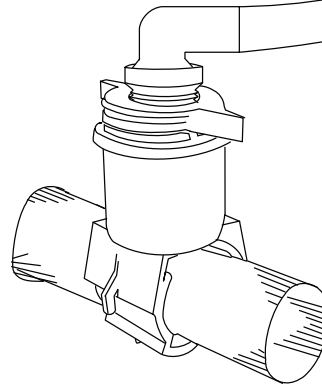

BS 2550 with Swing Pipe Fitting Application

## PACKAGING QTYS.

PART	OUTLET	PACKAGE	CARTON (MIN ORDER)
BS 2550	1/2" FPT	25	250
BS 2575	3/4" FPT	25	250
BS 2590	Swing Pipe Barb	25	250