



# BS 4000, 5000, & 6000

3/4" poly by Swing Pipe Barb

3/4" poly  
by 1/2" FPT

3/4" poly  
by 3/4" FPT

**Dimensions (installed):**

**BS 4000:**

- 4.0 inches - bottom of saddle to top of swing pipe barb
- 2.75 inches - top of pipe to top of swing pipe barb
- 2.60 inches at widest point

**BS 5000 & 6000:**

- 3.1 inches - bottom of saddle to top of spike
- 1.7 inches - top of pipe to top of spike
- 2.60 inches at widest point

- For use on 3/4" 80# or 100# polyethylene pipe\*
- 7 Gallons per minute at 40 PSI
- 12 Gallons per minute at 60 PSI
- 40% less friction loss than insert fittings
- Friction loss equivalent of 3.8 ft of pipe
- Withstands repeated freeze/thaw cycles and ground shift & sheering
- Made of high grade ABS material
- Tested to over 1 million on/off cycles without a leak

\*Withstands over 400 PSI without a leak. Pipe will burst first.

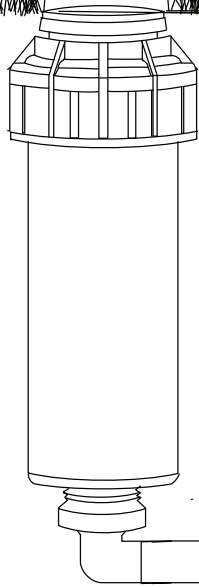
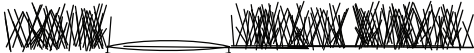
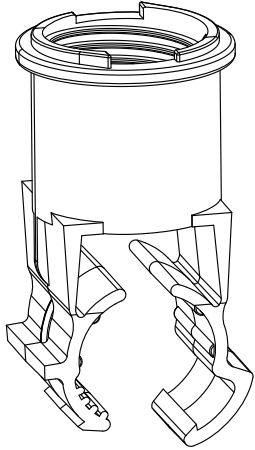

BS 4000 should be mounted horizontal

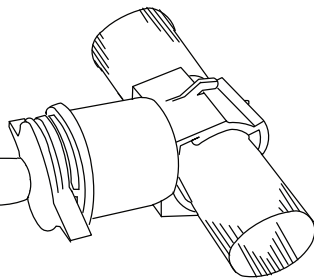

BS 5000 with Swing Pipe Fitting Application

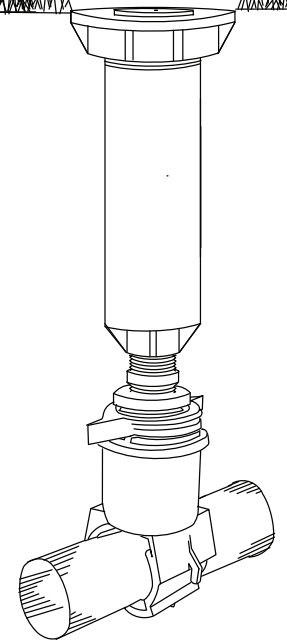
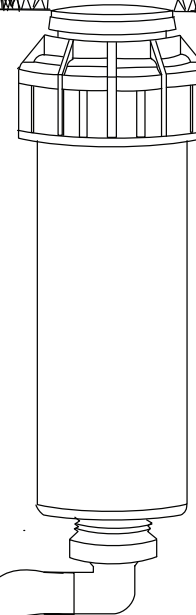
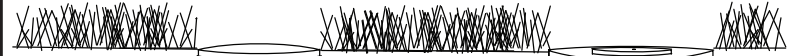
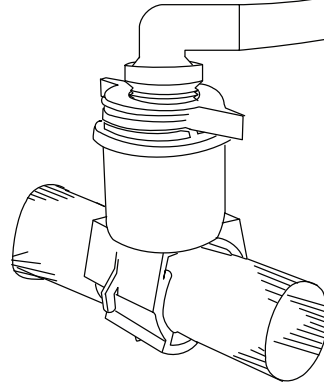

BS 6000 with 3/4" to 1/2" Riser Application

## PACKAGING QTYS.

PART	OUTLET	PACKAGE	CARTON (MIN ORDER)
BS 4000	Swing Pipe Barb	25	250
BS 5000	1/2" FPT	25	250
BS 6000	3/4" FPT	25	250